

SPECIFICATION OF SR TYPE SPEED CONTROL MOTORS

SIZE mm sq.	Motor Type	Controller Type	Poles	Output (W)	Voltage (V)	Freq. (Hz)	Duty	Speed Range (rpm)	Permissible Torque				Starting Torque		Cap. (μ F)
									at 1200rpm		at 90rpm		(kg-cm)	(N-m)	
90	S9I60GA()-S12 S9I60GA()-S12(TP) S9I60GA()-S12CE	SRA02 SRA02CE	4	60	1 ϕ 110	60	Cont.	90-1700	5.50	0.550	2.00	0.200	5.00	0.500	20.0
	S9I60GB()-S12 S9I60GB()-S12(TP) S9I60GB()-S12CE	SRB02 SRB02CE	4	60	1 ϕ 220	60	Cont.	90-1700	5.50	0.550	2.00	0.200	5.00	0.500	5.0
	S9I60GC()-S12 S9I60GC()-S12(TP) S9I60GC()-S12CE	SRC02 SRC02CE	4	60	1 ϕ 100	50 60	Cont.	90-1400 90-1700	5.50 5.00	0.550 0.500	1.20	0.120	4.00	0.400	20.0
	S9I60GD()-S12 S9I60GD()-S12(TP) S9I60GD()-S12CE	SRD02 SRD02CE	4	60	1 ϕ 200	50 60	Cont.	90-1400 90-1700	5.50 5.00	0.550 0.500	1.20	0.120	4.00	0.400	5.0
	S9I60GX()-S12 S9I60GX()-S12CE	SRX02 SRX02CE	4	60	1 ϕ 220 1 ϕ 240	50	Cont.	90-1400	5.20 5.80	0.520 0.580	0.90 0.90	0.090 0.090	3.10 3.60	0.310 0.360	3.5

- ❖ 기종명 맨 끝자리에 CE가 명기된 MOTOR MODEL의 인증 관련 내용은 SPG 규격 인증품 현황을 참고하여 주십시오.
- ❖ 기종명 맨 끝자리에 (TP)가 명기된 MOTOR MODEL은 일반 MOTOR의 TP가 내장된 THERMALLY PROTECTED TYPE입니다.
또한 기종명 S9I60GX()-S12, S9I60GX()-S12CE는 TP가 내장된 THERMALLY PROTECTED TYPE입니다.
- ❖ ()는 L, H Type을 표시합니다. L은 GEAR HEAD의 L과, H는 GEAR HEAD의 H와 사용하여 주십시오.

SPECIFICATION OF SS TYPE SPEED CONTROL MOTORS

SIZE mm sq.	Motor Type	Controller Type	Poles	Output (W)	Voltage (V)	Freq. (Hz)	Duty	Speed Range (rpm)	Permissible Torque				Starting Torque		Cap. (μ F)
									at 1200rpm		at 90rpm		(kg-cm)	(N-m)	
90	S9I60GA()-S24 S9I60GA()-S24(TP) S9I60GA()-S24CE	SSA03-SRSS	4	60	1 ϕ 110	60	Cont.	90-1700	5.50	0.550	2.00	0.200	5.00	0.500	20.0
	S9I60GB()-S24 S9I60GB()-S24(TP) S9I60GB()-S24CE	SSB03-SRSS	4	60	1 ϕ 220	60	Cont.	90-1700	5.50	0.550	2.00	0.200	5.00	0.500	5.0
	S9I60GC()-S24 S9I60GC()-S24(TP) S9I60GC()-S24CE	SSC03-SRSS	4	60	1 ϕ 100	50 60	Cont.	90-1400 90-1700	5.50 5.00	0.550 0.500	1.20	0.120	4.00	0.400	20.0
	S9I60GD()-S24 S9I60GD()-S24(TP) S9I60GD()-S24CE	SSD03-SRSS	4	60	1 ϕ 200	50 60	Cont.	90-1400 90-1700	5.50 5.00	0.550 0.500	1.20	0.120	4.00	0.400	5.0
	S9I60GX()-S24 S9I60GX()-S24CE	SSX03-SRSS	4	60	1 ϕ 220 1 ϕ 240	50	Cont.	90-1400	5.20 5.80	0.520 0.580	0.90 0.90	0.090 0.090	3.10 3.60	0.310 0.360	3.5

- ❖ 기종명 맨 끝자리에 CE가 명기된 MOTOR MODEL의 인증 관련 내용은 SPG 규격 인증품 현황을 참고하여 주십시오.
- ❖ 기종명 맨 끝자리에 (TP)가 명기된 MOTOR MODEL은 일반 MOTOR의 TP가 내장된 THERMALLY PROTECTED TYPE입니다.
또한 기종명 S9I60GX()-S24, S9I60GX()-S24CE는 TP가 내장된 THERMALLY PROTECTED TYPE입니다.
- ❖ ()는 L, H Type을 표시합니다. L은 GEAR HEAD의 L과, H는 GEAR HEAD의 H와 사용하여 주십시오.

50Hz

GEAR RATIO	3	3.6	5	6	7.5	9	10	12.5	15	18	20	25	30	36	40	50	60	75	90	100	120	150	180	200
MODEL rpm	500	416	300	250	200	166	150	120	100	83	75	60	50	41	37	30	25	20	16	15	12	10	8	7.5
S9KC□B() kg·cm	12.2	14.6	20.3	24.3	30.4	36.5	40.5	45.6	54.8	65.7	73.0	82.5	99.0	119	132	165	198	200	200	200	200	200	200	200
S9KC□B()-S Nm	1.196	1.431	1.989	2.381	2.989	3.577	3.969	4.469	5.370	6.439	7.154	8.085	9.702	11.66	12.94	16.17	19.40	19.60	19.60	19.60	19.60	19.60	19.60	19.60

60Hz

GEAR RATIO	3	3.6	5	6	7.5	9	10	12.5	15	18	20	25	30	36	40	50	60	75	90	100	120	150	180	200
MODEL rpm	600	500	360	300	240	200	180	144	120	100	90	72	60	50	45	36	30	24	20	18	15	12	10	9
S9KC□B() kg·cm	9.72	11.7	16.2	19.4	24.3	29.2	32.4	36.5	43.8	52.6	58.4	66.0	79.2	95.0	106	132	158	177	200	200	200	200	200	200
S9KC□B()-S Nm	0.953	1.147	1.588	1.901	2.381	2.862	3.175	3.577	4.292	5.155	5.723	6.468	7.762	9.310	10.39	12.94	15.48	17.35	19.60	19.60	19.60	19.60	19.60	19.60

- ❖ GEAR HEAD 품명 중 □은 감속비를 표시합니다.
- ❖ GEAR HEAD와 조합한 경우의 허용 TORQUE입니다.
감속비 1/10의 중간 GEAR HEAD를 접속한 경우의 허용 TORQUE는 200kg·cm입니다.
- ❖ 회전방향은 ■색이 MOTOR의 회전방향과 동일방향이고, 기타는 MOTOR 회전방향과 반대방향입니다.
- ❖ 회전수는 MOTOR의 동기 회전수(50Hz : 1500rpm, 60Hz : 1800rpm)를 기준으로 하여 감속비로 나누어서 계산하였습니다.
실제의 회전수는 부하의 크기에 따라서 표시된 수치보다 2~20% 적습니다.
- ❖ ()는 L, H Type을 표시합니다. L은 MOTOR의 L과, H는 MOTOR의 H와 사용하여 주십시오.

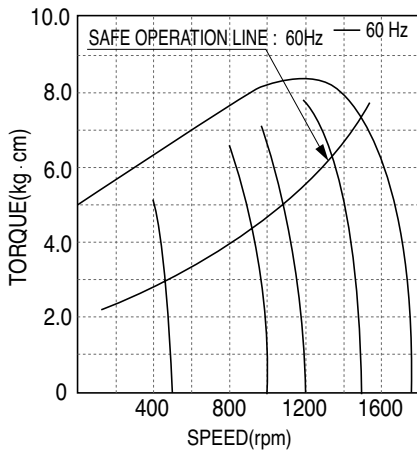

- ▲ S9I60GA()-S12 S9I60GA()-S24
- S9I60GA()-S12(TP) S9I60GA()-S24(TP)
- S9I60GA()-S12CE S9I60GA()-S24CE
- S9I60GB()-S12 S9I60GB()-S24
- S9I60GB()-S12(TP) S9I60GB()-S24(TP)
- S9I60GB()-S12CE S9I60GB()-S24

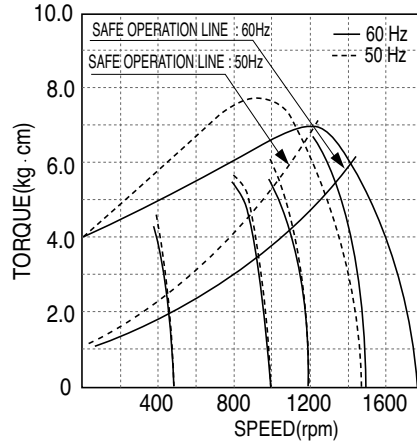

- ▲ S9I60GC()-S12 S9I60GC()-S24
- S9I60GC()-S12(TP) S9I60GC()-S24(TP)
- S9I60GC()-S12CE S9I60GC()-S24CE
- S9I60GD()-S12 S9I60GD()-S24
- S9I60GD()-S12(TP) S9I60GD()-S24(TP)
- S9I60GD()-S12CE S9I60GD()-S24

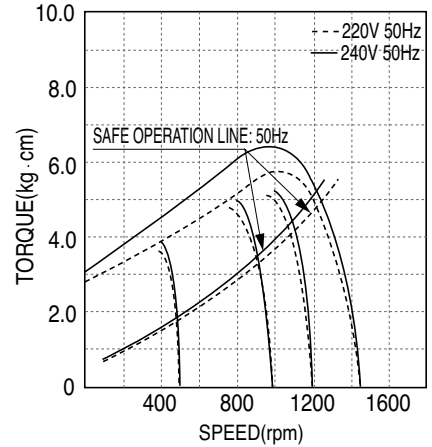

- ▲ S9I60GX()-S12 S9I60GX()-S24
- S9I60GX()-S12CE S9I60GX()-S24CE

DIMENSIONS

+ GEARED MOTOR

* MOTOR MODEL : S9160G□□-S12, S9160G□□-S24
 * HEAD MODEL : S9□C3B□-S ~ S9□C200B□-S

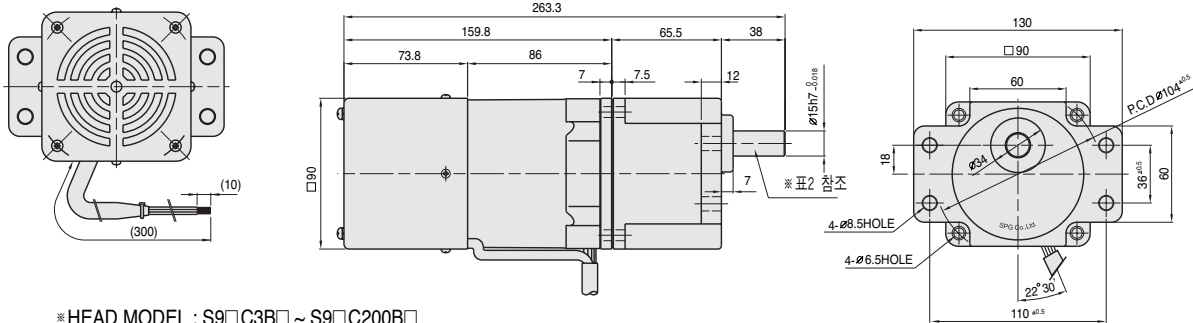

* HEAD MODEL : S9□C3B□ ~ S9□C200B□

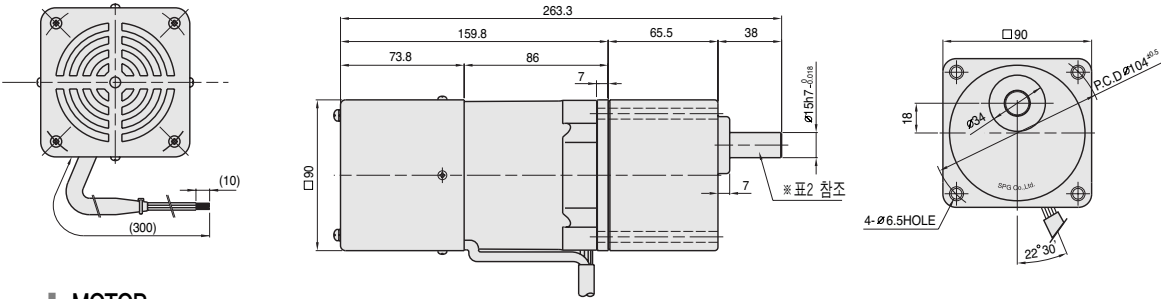

+ MOTOR

* MOTOR MODEL : S9160□□□-S12, S9160□□□-S24

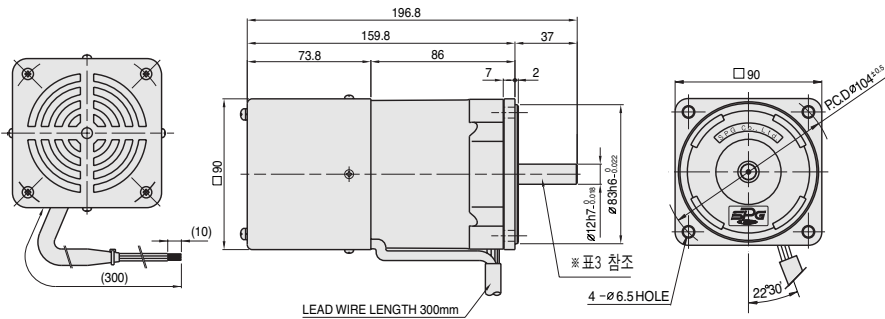

LEAD WIRE LENGTH 300mm

+ INTER-DECIMAL GEAR HEAD

* MODEL : S9GX10B(H,L)-S

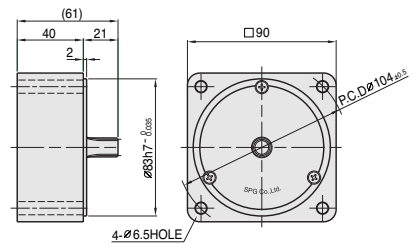



+ WEIGHT - (표1)

PART	WEIGHT(kg)	
MOTOR	2.93	
DECIMAL GEAR HEAD	0.65	
GEAR HEAD	S9□C3B□ ~S9□C10B□	1.21
	S9□C12.5B□ ~S9□C20B□	1.30
	S9□C25B□ ~S9□C60B□	1.40
	S9□C75B□ ~S9□C200B□	1.45

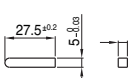
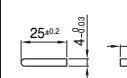

+ KEY SPEC

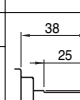
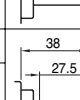
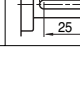
GEAR HEAD	MOTOR
	

+ GEAR HEAD 출력축 사양 - (표2)

MODEL	출력축 구분
STRAIGHT TYPE	
S9SC3B□ ~S9SC200B□	
D-CUT TYPE	
S9DC3B□ ~S9DC200B□	
KEY TYPE	
S9KC3B□ ~S9KC200B□	

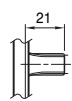
+ MOTOR 출력축 사양 - (표3)

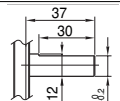
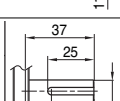
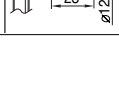
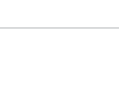
MODEL	출력축 구분
GEAR TYPE	
S9160G□-S12 S9160G□-S24	
STRAIGHT TYPE	
S9160S□-S12 S9160S□-S24	
D-CUT TYPE	
S9160D□-S12 S9160D□-S24	
KEY TYPE	
S9160K□-S12 S9160K□-S24	

DIMENSIONS

+ GEARED MOTOR

- * MOTOR MODEL : S9I60G□H-S12, S9I60G□H-S24
- * HEAD MODEL : S9□D3B-S9□D200B

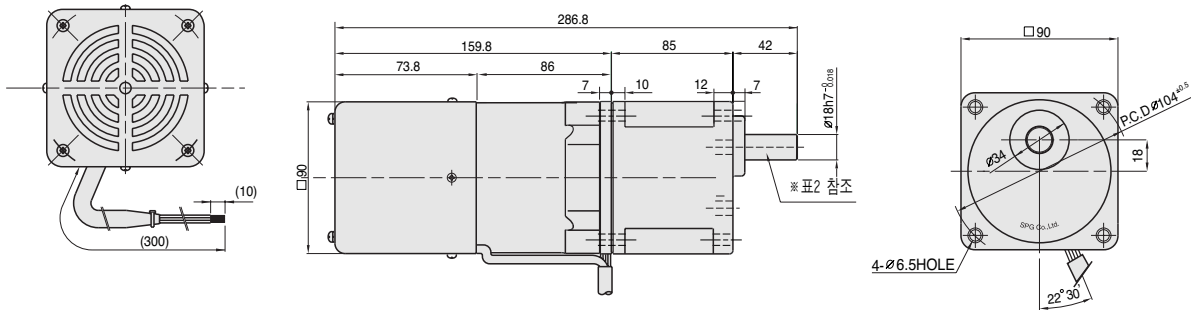

+ WEIGHT - (표1)

PART		WEIGHT(kg)
MOTOR		2.93
GEAR HEAD	S9□D3B ~S9□D10B	1.65
	S9□D12.5B ~S9□D20B	1.80
	S9□D25B ~S9□D60B	1.90
	S9□D75B ~S9□D200B	1.95

+ GEAR HEAD 출력축 사양 - (표2)

MODEL	출력축 구분
STRAIGHT TYPE	
S9SD3B ~S9SD200B	
D-CUT TYPE	
S9DD3B ~S9DD200B	
KEY TYPE	
S9KD3B ~S9KD200B	

+ KEY SPEC

GEAR HEAD	

50Hz

MODEL	GEAR RATIO	3	3.6	5	6	7.5	9	10	12.5	15	18	20	25	30	36	40	50	60	75	90	100	120	150	180	200
	S9KD□B	rpm	500	416	300	250	200	166	150	120	100	83	75	60	50	41	37	30	25	20	16	15	12	10	8
kg-cm		18.2	21.9	30.4	36.5	45.6	54.7	60.8	68.4	82.1	98.6	110	124	149	178	198	248	297	300	300	300	300	300	300	300
N·m		1.784	2.146	2.979	3.577	4.469	5.361	5.958	6.703	8.046	9.663	10.78	12.15	14.60	17.44	19.40	24.32	29.13	29.42	29.42	29.42	29.42	29.42	29.42	29.42

60Hz

MODEL	GEAR RATIO	3	3.6	5	6	7.5	9	10	12.5	15	18	20	25	30	36	40	50	60	75	90	100	120	150	180	200
	S9KD□B	rpm	600	500	360	300	240	200	180	144	120	100	90	72	60	50	45	36	30	24	20	18	15	12	10
kg-cm		14.6	17.5	24.3	29.2	36.5	43.7	48.6	54.8	65.7	78.8	87.6	99.0	119	143	158	198	238	266	300	300	300	300	300	300
N·m		1.431	1.715	2.381	2.862	3.577	4.675	4.763	5.370	6.439	7.722	8.585	9.702	11.66	14.01	15.48	19.40	23.34	26.09	29.42	29.42	29.42	29.42	29.42	29.42

- ❖ GEAR HEAD 품명 중 □은 감속비를 표시합니다.
- ❖ GEAR HEAD와 조합한 경우의 허용 TORQUE입니다.
감속비 1/10의 중간 GEAR HEAD를 접속한 경우의 허용 TORQUE는 300kg-cm입니다.
- ❖ 회전방향은 ■색이 MOTOR의 회전방향과 동일방향이고, 기타는 MOTOR 회전방향과 반대방향입니다.
- ❖ 회전수는 MOTOR의 동기 회전수(50Hz : 1500rpm, 60Hz : 1800rpm)를 기준으로 하여 감속비로 나누어서 계산하였습니다.
실제의 회전수는 부하의 크기에 따라서 표시된 수치보다 2~20% 적습니다.
- ❖ 'H' Type 전용으로 기중명에 표시하지 않습니다. MOTOR의 H와 사용하여 주십시오.