



6W

INDUCTION SPEED CONTROL MOTOR
 60mm CONNECTOR TYPE

SIZE mm sq.	Motor Type	Controller Type	Poles	Output (W)	Voltage (V)	Freq. (Hz)	Duty	Speed Range (rpm)	Permissible Torque				Starting Torque		Cap. (μF)
									at 1200rpm		at 90rpm		(kg-cm)	(N-m)	
60	S6I06GA-V12 S6I06GA-V12CE	SUA06IA-V12	4	6	1 ∅ 110	60	Cont.	90-1700	0.55	0.055	0.40	0.040	0.52	0.052	2.5
	S6I06GB-V12 S6I06GB-V12CE	SUA06IB-V12	4	6	1 ∅ 220	60	Cont.	90-1700	0.55	0.055	0.40	0.040	0.52	0.052	0.7
	S6I06GC-V12 S6I06GC-V12CE	SUA06IC-V12	4	6	1 ∅ 100	50	Cont.	90-1400	0.48	0.048	0.30	0.030	0.40	0.040	2.5
	60					90-1700									
	S6I06GD-V12 S6I06GD-V12CE	SUA06ID-V12	4	6	1 ∅ 200	50	Cont.	90-1400	0.48	0.048	0.30	0.030	0.40	0.040	0.7
	60					90-1700									
	S6I06GX-V12 S6I06GX-V12CE	SUA06IX-V12	4	6	1 ∅ 220	50	Cont.	90-1400	0.35	0.035	0.22	0.022	0.35	0.035	0.7
	1 ∅ 240				0.45				0.045	0.22	0.022	0.42	0.042		

- 기종명 맨 끝자리에 CE가 명기된 MOTOR MODEL의 인증 관련 내용은 SPG 규격 인증품 현황을 참고하여 주십시오.
- 'L' Type 전용으로 기종명에 표시하지 않습니다.

50Hz

GEAR RATIO	3 3.6 5 6 7.5 9 10 12.5 15 18 20 25 30 36 40 50 60 75 90 100 120 150 180 200 250																										
	MODEL	rpm	500	416	300	250	200	166	150	120	100	83	75	60	50	41	37	30	25	20	16	15	12	10	8	7.5	6
S6DA□B	kg-cm	1.3	1.5	2.1	2.6	3.2	3.9	4.3	5.4	6.4	7.7	7.7	9.7	11.6	13.9	15.5	17.5	21.0	26.2	30.0	30.0	30.0	30.0	30.0	30.0	30.0	30.0
	N-m	0.127	0.147	0.206	0.255	0.314	0.382	0.421	0.529	0.627	0.755	0.755	0.951	1.137	1.362	1.519	1.715	2.058	2.568	2.942	2.942	2.942	2.942	2.942	2.942	2.942	2.942

60Hz

GEAR RATIO	3 3.6 5 6 7.5 9 10 12.5 15 18 20 25 30 36 40 50 60 75 90 100 120 150 180 200 250																										
	MODEL	rpm	600	500	360	300	240	200	180	144	120	100	90	72	60	50	45	36	30	24	20	18	15	12	10	9	7.2
S6DA□B	kg-cm	1.0	1.3	1.7	2.1	2.6	3.1	3.5	4.4	5.2	6.3	6.3	7.8	9.4	11.3	12.6	14.2	17.0	21.3	25.5	28.4	30.0	30.0	30.0	30.0	30.0	30.0
	N-m	0.098	0.127	0.167	0.206	0.255	0.304	0.343	0.431	0.510	0.617	0.617	0.764	0.921	1.107	1.235	1.392	1.666	2.087	2.499	2.783	2.942	2.942	2.942	2.942	2.942	2.942

- GEAR HEAD 품명 중 □은 감속비를 표시합니다.
- GEAR HEAD와 조합한 경우의 허용 TORQUE입니다. 감속비 1/10의 중간 GEAR HEAD를 접속한 경우의 허용 TORQUE는 30kg-cm입니다.
- 회전방향은 색이 MOTOR의 회전방향과 동일방향이고, 기타는 MOTOR 회전방향과 반대방향입니다.
- 회전수는 MOTOR의 동기 회전수(50Hz : 1500rpm, 60Hz : 1800rpm)를 기준으로 하여 감속비로 나누어서 계산하였습니다. 실제의 회전수는 부하의 크기에 따라서 표시된 수치보다 2~20% 적습니다.
- 'L' Type 전용으로 기종명에 표시하지 않습니다.

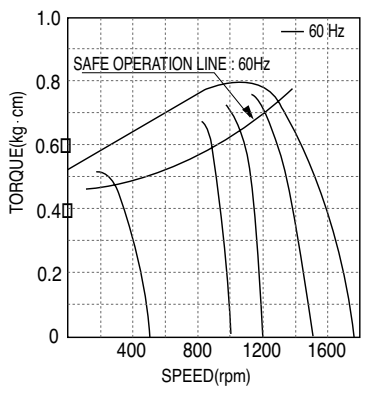

▲ S6I06GA-V12, S6I06GB-V12
S6I06GA-V12CE, S6I06GB-V12CE

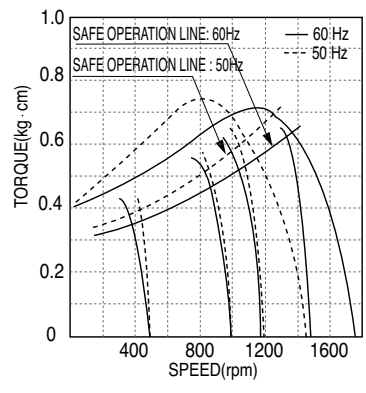

▲ S6I06GC-V12, S6I06GD-V12
S6I06GC-V12CE, S6I06GD-V12CE

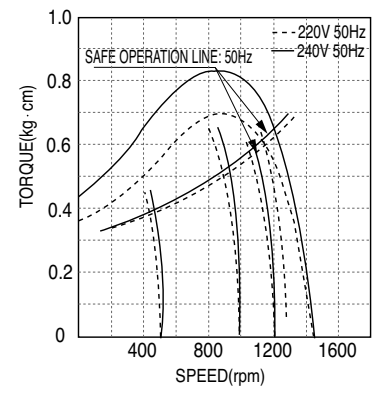

▲ S6I06GX-V12
S6I06GX-V12CE

DIMENSIONS

+ GEARED MOTOR

* MOTOR MODEL : S6I06G□-V12
 * HEAD MODEL : S6□A3□~S6□A250□

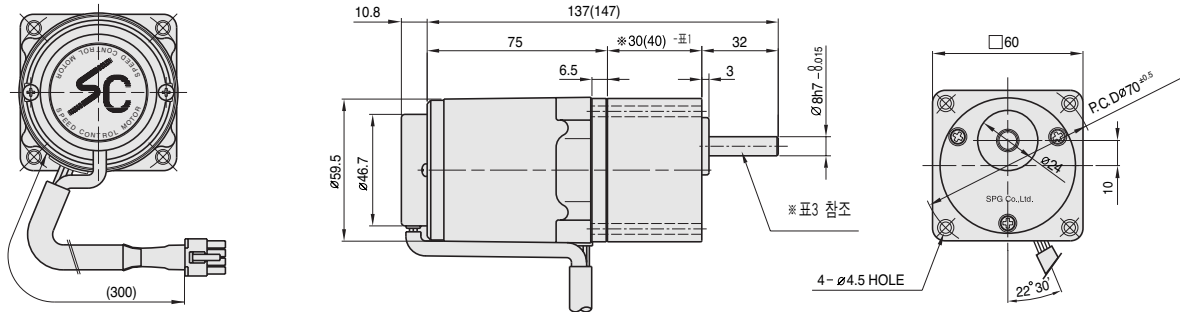

+ MOTOR

* MOTOR MODEL : S6I06□□-V12

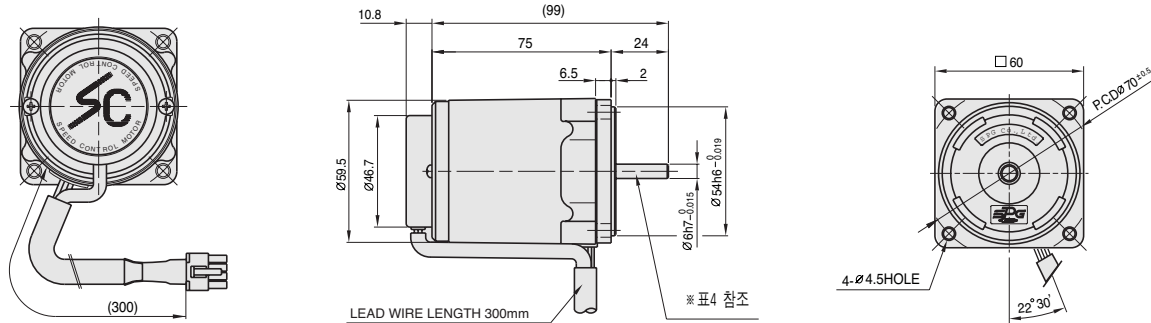

+ INTER-DECIMAL GEAR HEAD

* MODEL : S6GX10B

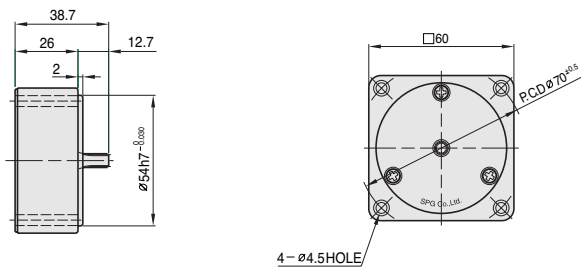

+ KEY SPEC

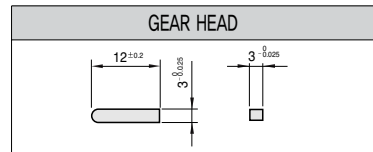

+ ※30(40) - (표1)

GEAR RATIO	SIZE(mm)
S6□A3□ ~ S6□A18□	30
S6□A20□ ~ S6□A250□	40

+ WEIGHT - (표2)

PART	WEIGHT(kg)	
MOTOR	0.76	
DECIMAL GEAR HEAD	0.18	
GEAR HEAD	S6□A3□ ~ S6□A18□	0.24
	S6□A20□ ~ S6□A40□	0.30
	S6□A50□ ~ S6□A250□	0.33

+ GEAR HEAD 출력축 사양 - (표3)

MODEL	출력축 구분
STRAIGHT TYPE	
S6SA3□ ~ S6SA250□	
D-CUT TYPE	
S6DA3□ ~ S6DA250□	
KEY TYPE	
S6KA3□ ~ S6KA250□	

+ MOTOR 출력축 사양 - (표4)

MODEL	출력축 구분
GEAR TYPE	
S6I06G□-V12	
STRAIGHT TYPE	
S6I06S□-V12	
D-CUT TYPE	
S6I06D□-V12	